

# HITACHI

## AX-M140

### Instruction Manual



Mini Hi-Fi Component System



# Table of Contents

---

Before Connection .....	3
For your safety .....	3
Precautions .....	3
Connection .....	5
Connect to the TV .....	5
Connecting the Speakers .....	5
Connecting the Antenna .....	5
Connecting Control Cable .....	6
Connect to the amplifier with digital signal input terminal .....	6
Connect to the VCR .....	6
Connecting to a PC .....	7
Connecting the AC Power Cord .....	7
Connecting the Headphones .....	7
Control Locations .....	7
The DVD Player .....	7
The DAB / FM RADIO .....	8
The MP3 Player .....	8
The Amplifier .....	8
Remote control .....	9
Installation of Batteries in the Remote Control .....	10
Turning the Power On and Off .....	10
Button Functions .....	10
DVD Menu Options .....	14
Menu function setup .....	14
General Setup Page .....	15
Audio Setup Page .....	15
Video Setup Page .....	15
Preference Page .....	16
Password Setup Page .....	16
Picture CD's .....	16
DAB/FM Radio .....	17
MP3 Functions .....	21
Listening to MP3 Player .....	21
MP3 Recording .....	22
Clock/Timer Functions .....	24
Setting the Daily Timer .....	25
Setting the Sleep Timer .....	25
Protect the Disc .....	26
Troubleshooting .....	26
Specification .....	27

Manufactured under license from Dolby Laboratories.  
"Dolby", "Pro Logic" and the double-D symbol are trademarks of Dolby Laboratories.

## Disc types

	Audio & Video	Disc size 12cm single side, single layer / single side, double layer PAL and NTSC DVD disc Playback time 135min/240min max.
	Audio	Disc size 12cm / 8cm CD Disc Playback time 74min/20min
MP3	Audio	MP3 Format disc

\* **Player is CD-R, CD-RW compatible**

**Note:** CD-R, CD-RW Discs recorded with writing device can only be used when they are correctly treated.

\* **Region Management Information**





This DVD Player is designed and manufactured to respond to the Region Management Information that is recorded on a DVD disc. If the Region number described on the DVD disc does not correspond to the Region number of this DVD Player, this DVD Player cannot play that disc.

This Region number of this DVD Player is .

# Before Connection

Thank you for purchasing this hi-fi component system, in order to fully utilize this system, please read this instruction book carefully before use.

## For your safety

 <div style="border: 1px solid black; padding: 5px; text-align: center;"><b>CAUTION</b> <b>RISK OF ELECTRIC SHOCK</b> <b>DO NOT OPEN</b></div>  <p><b>CAUTION:</b> TO REDUCE THE RISK OF ELECTRIC SHOCK, DO NOT REMOVE COVER. NO USER SERVICEABLE PARTS INSIDE, REFER SERVICING TO QUALIFIED SERVICE PERSONNEL.</p>	 <p>This symbol indicates that dangerous voltage constituting a risk of electric shock is present within this unit.</p>  <p>This symbol indicates that there are important operating and maintenance instructions in the literature accompanying this unit.</p>
---	---

**Caution:**

To prevent fire or shock hazard, do not expose this equipment to rain or moisture.

**Power Requirement**

Because the power requirement of electrical products is different in various places, before you use this product, make sure that the power requirement of the product matches your household power.

**Laser Product**

This product is equipped with low power laser equipment inside. For your safety, don't take apart any covers or try to take apart the product inside. Please contact an authorized service person for repairing.



**Caution:**  
This product is equipped with low power laser equipment inside, for your safety, don't open the laser radiation protective equipment. Don't look at the laser radiation when the equipment is operating.

## Precautions

This equipment has been designed and manufactured to meet international safety standards but, like any electrical equipment, care must be taken if you are to obtain the best results and safety is to be assured.

- .....
- DO** read the operating instructions before you attempt to use the equipment.
- DO** ensure that all electrical connections (including the mains plug, extension leads and inter-connections between the pieces of equipment) are properly made and in accordance with the manufacturer's instructions. Switch off and withdraw the mains plug before making or changing connections.
- DO** consult your dealer if you are ever in doubt about the installation, operation or safety of your equipment.
- DO** be careful with glass panels or doors on equipment

.....  
**DON'T** remove any fixed cover as this may expose dangerous voltages.

- DON'T** obstruct the ventilation openings of the equipment with items such as newspapers, tablecloths, curtains, etc. Overheating will cause damage and shorten the life of the equipment.
- DON'T** allow electrical equipment to be exposed to dripping or splashing, or objects filled with liquids, such as vases, to be placed on the equipment and don't handle the power cord with wet hands.
- DON'T** place hot objects or naked flame sources such as lighted candles or nightlights on, or close to equipment. High temperatures can melt plastic and lead to fires.
- DON'T** use makeshift stands and **NEVER** fix legs with wood screws - to ensure complete safety always fit the manufacturer's approved stand or legs with the fixings provided according to the instructions.
- DON'T** listen to headphones at high volume, as such use can permanently damage your hearing.
- DON'T** leave equipment switched on when it is unattended unless it is specifically stated that it is designed for unattended operation or has a stand-by mode. Switch off using the switch on the equipment and make sure that your family knows how to do this. Special arrangements may need to be made for infirm or handicapped people.
- DON'T** continue to operate the equipment if you are in any doubt about it working normally, or if it is damaged in any way - switch off, withdraw the mains plug and consult your dealer.

.....

ABOVEALL,

- NEVER** let anyone especially children push anything into holes, slots or any other opening in the case - this could result in a fatal electrical shock;
- NEVER** guess or take chances with electrical equipment of any kind... it is better to be safe than sorry!

- .....
- \* Before operating this system, check the voltage of this system to see if it is identical with the voltage of your local power supply.
  - \* Unplug the system from the wall outlet if it is not used for a long time. To disconnect the cord, pull it out by grasping the plug
  - \* To avoid electric shock, do not open the cabinet.
  - \* There are no user serviceable parts inside. In case of system failure, unplug the power cord and consult your dealer
  - \* Do not place this unit on an unstable or sloping surface. Ensure good ventilation surrounding the product. To prevent fire, do not cover the ventilation of the apparatus with news papers, table-cloths, curtains, etc.
  - \* Do not place this unit close to strong magnetic field.
  - \* Don't place this unit close to dampness, or the moisture will affect the life of the laser head.
  - \* If the system is brought directly from a cold to a warm location, or is placed in a very damp room, moisture may condense on the lens inside the player. Should this occur, the system will not operate properly. Remove the disc and leave the system turned on for about an hour until the moisture evaporates.
  - \* Should any solid object or liquid fall into the system, unplug the system and have it checked by qualified personnel before operating it again.
  - \* Do not use attachments not recommended by the product manufacturer as they may cause hazards.

# Connection

**Caution:** Please turn off all the equipment power before connecting.

## Connect to the TV

### Connecting diagram

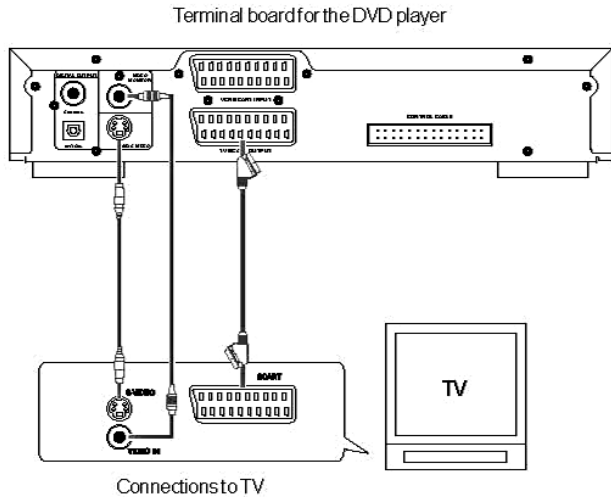

### Safety precautions

Some settings should be made for the unit according to the TV connection.

- \* According to the colour system setting of TV, select the colour system in the "TV Display" function setting.
- \* If the unit is connected to a wide screen TV, then set the "TV display" to "Wide" in the function setting menu.
- \* If the unit is connected to a TV, then set "TV display" to "Normal/PS" or "Normal/LB" in the function setting item.

## Connecting the Speakers

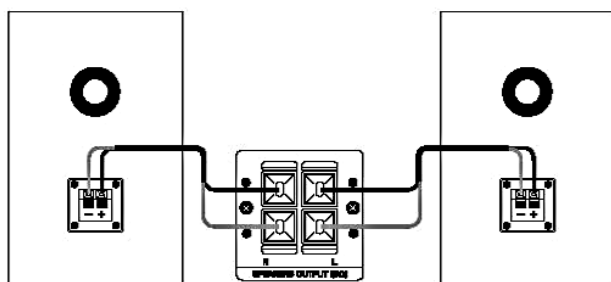

Connect the speaker cords between the terminals as shown below.

Connect the cords with a silver line to the (+) (L) (R) terminals and cords with a gold line to the (-) (G) terminals.

### Connection precautions

1. This unit has a high power output and wide dynamic range. If speakers other than those supplied are used, they must be chosen according to speaker specification, or the speakers may be damaged.
2. Before connecting or removing mains power, please turn off the power on the unit and turn the volume to minimum or it may damage the speakers.

## Connecting the Antenna

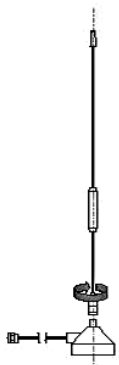

Tighten the antenna rod clockwise on the base of the antenna.

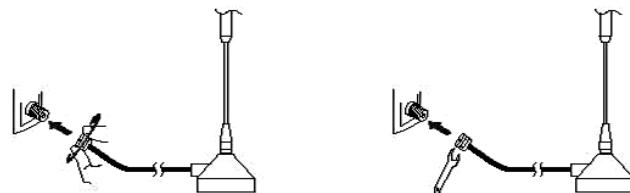

- \* The antenna should be connected to the antenna socket, tighten the antenna by hand with tool supplied. (**Please note:** Do not overtighten, this could damage the antenna or it's fittings.)
- \* Position the antenna for the best reception.

**Warning:** The antenna supplied has a magnetic base. It must not be placed on any products that are sensitive to magnetism, such a TV's and computers as this may cause damage.

## Connecting Control Cable

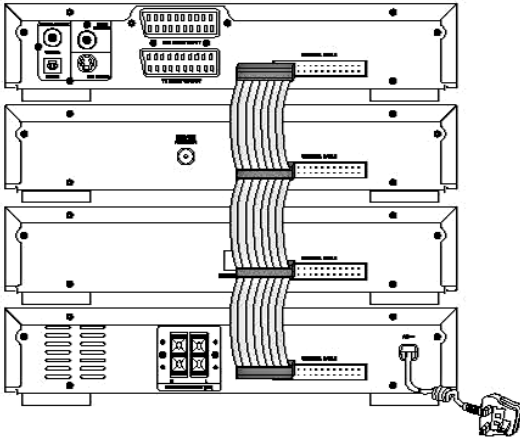

With the unit unplugged from the mains connect the power control cable to the DVD player, MP3 player, the amplifier and the radio via the connections on the rear of the units as shown .

## Connect to the amplifier with digital signal input terminal

DVD player connections

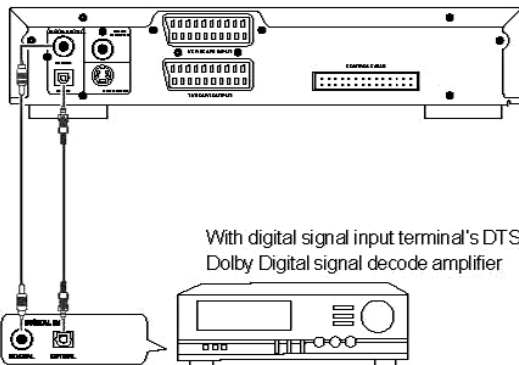

With digital signal input terminal's DTS, Dolby Digital signal decode amplifier terminal board

### Connection precautions

Please note: You can only use coaxial or optical, they can not be used at the same time.

## Connect to the VCR

Terminal board for the DVD player

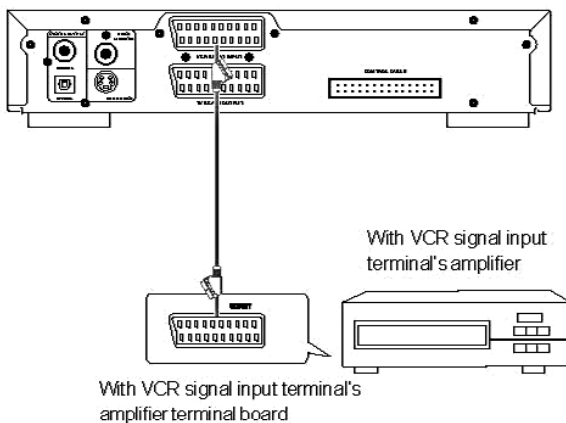

## Connecting to a PC

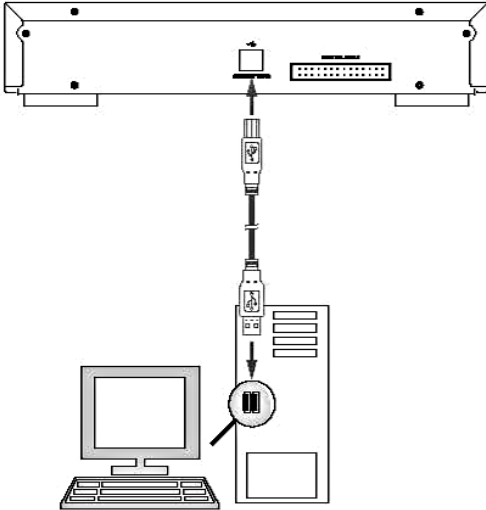

The AX-M140 can be connected to a PC via the USB (B) Port on the rear of the unit. Music files on your PC can then be transferred to the Music bank for storage and play back through the AX-M140 Hi-Fi. Your PC should see the AX-M140 Music bank as an external hard drive/storage device then files can be copied, pasted and deleted as desired.

## Connecting the AC Power Cord

Insert the AC power cord into a wall outlet, and your system is ready for use.

**Caution:** Be sure to unplug the power cord from the outlet when going away or when the system is not in use for an extended period of time.

## Connecting the Headphones

Connect a pair of headphones to the phone jacks. No sound comes out of the speakers.

**Note:** Be sure to turn down the volume before connecting or putting on headphones.

## Control Locations

---

### The DVD Player

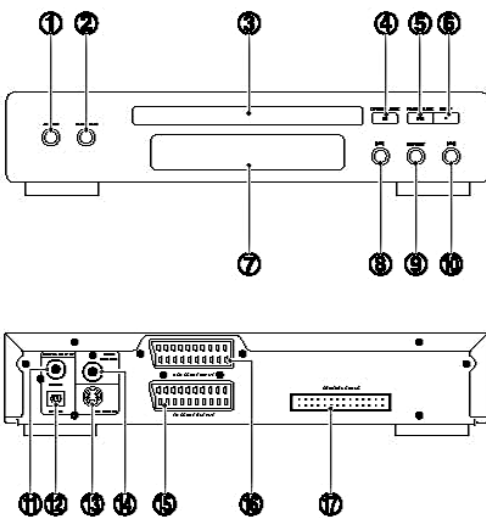

1. Vocal Mode Select / Language Select
2. Subtitle
3. Disc Tray
4. Open/Close
5. Play/Pause
6. Stop
7. VFD Display Lens
8. Previous
9. Repeat
10. Next
11. Digital Audio Out Coaxial
12. Digital Audio Out Optical
13. S-Video Output Terminal
14. Video Monitor Terminal
15. TV Scart Output
16. VCR Scart Input
17. Control Cable Connector



## The DAB / FM RADIO

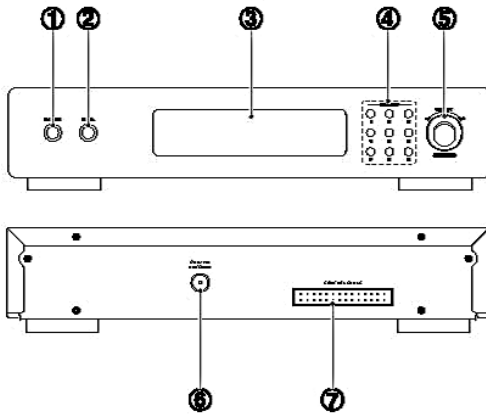

1. DAB/FM Switch
2. Information
3. VFD Display Lens
4. Number Buttons
5. Confirm  
Select Down  
Select Up
6. DAB/FM Antenna Jack
7. Control Cable Connector

## The MP3 Player

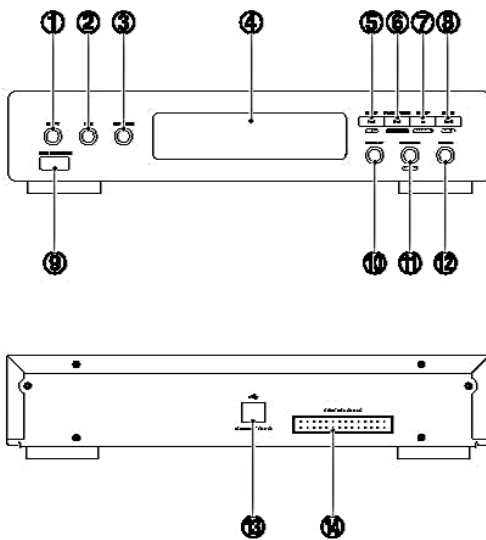

1. File Copy
2. Record
3. CD-SYNC Record
4. VFD Display Lens
5. Previous  
Menu Select Down
6. Play/Pause  
Menu Confirm
7. Stop  
Menu Cancel
8. Next  
Menu Select Up
9. USB Storage Port/Portable MP3 connection
10. Repeat
11. Random  
Menu
12. Intro
13. USB Port (PC Connection )
14. Control Cable Connector

## The Amplifier

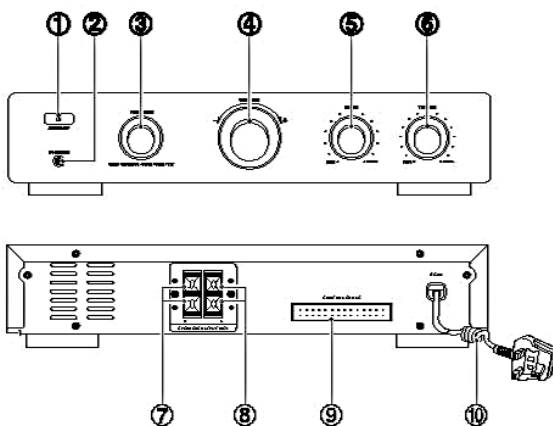

1. Standby
2. Headphone Jack
3. Function
4. Volume Control Knob
5. Bass Control Knob
6. Treble Control Knob
7. Right Speaker Output Terminals
8. Left Speaker Output Terminals
9. Control Cable Connector
10. AC Power Cord

## Remote control

1. Standby
2. DVD Function
3. DAB/FM Function
4. Clock
5. Sleep
6. Clock Dimmer (In standby mode)
7. Loudness
8. Preset Equalizer
9. Volume Up
10. Fast Reverse
11. Menu Select Down
12. Volume Down
13. Previous Information
14. Play/Pause
15. Menu Confirm
16. Repeat
17. Number
18. Direction (◀)
19. Enter Button
20. PBC
21. Menu
22. Function Setting
23. Subtitle
24. OSD
25. Mute
26. MP3 Function
27. TV/CR Function
28. Random
29. Menu Setting
30. Intro
31. Record
32. File Copy
33. Fast Forward
34. Menu Select Up
35. Next Scan
36. Stop
37. Menu Cancel
38. Program
39. Time Search
40. Direction (▲)
41. Direction (▶)
42. Direction (▼)
43. Title
44. Zoom
45. Angle Select
46. Vocal Mode Select
47. Language Select

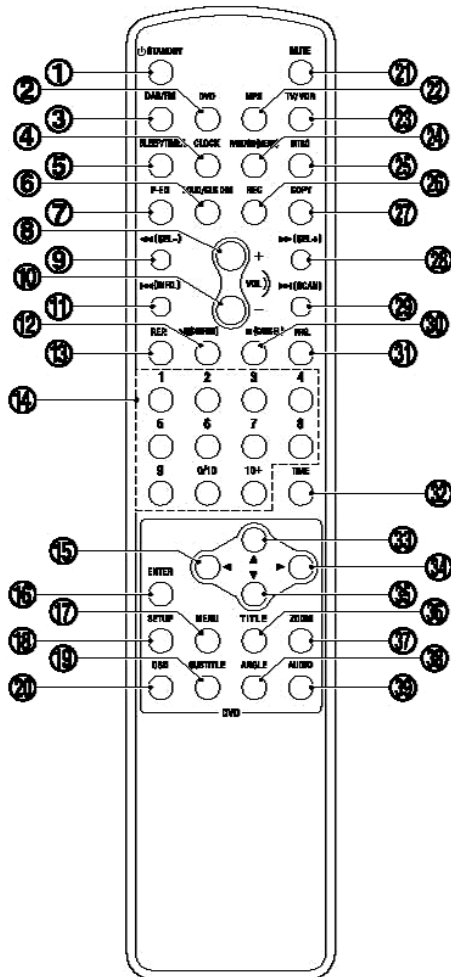

## Installation of Batteries in the Remote Control

---

1. Remove the battery compartment cover.
  2. Insert two batteries (size AAA) correctly, so that the + and - polarities match the polarity diagrams in the battery compartment.
- \* About half a year of normal operation can be expected when using standard batteries.
  - \* When the batteries are exhausted, the remote will not function. Replace both batteries at the same time with new ones.
  - \* Don't mix old and new batteries.
  - \* Don't mix different types of batteries.
  - \* When the unit is not used for a long period of time, remove the batteries to avoid damage caused by battery leakage and corrosion.

## Turning the Power On and Off

---

### Turning the System On

Press the standby button (STANDBY) to turn the system on from standby mode.

**Caution:** When turning the system on, the system will continue in the mode it was in when it was turned off last time.

### Turning the System Off

Press the standby button (STANDBY) again to turn the system off (called Standby Mode).

**Caution:** Be sure to unplug the power cord from the outlet when going away or when the system is not in use for an extended period of time.

## Button Functions

---

**Note:** When the unit is in VCR mode, the VCR connected with the unit by the scart cable is for playing only. If you want to record, the unit must be in standby mode.

DVD







In power on mode, press the DVD function button (DVD) to select DVD function.

OPEN/CLOSE





Press the open/close button () on the unit to open the disc tray then place the disc on the disc tray (with the printed side up). Press this button again to close the disc tray, the unit will read the disc and the disc type will display on the TV screen. The disc should play automatically.



Press the direction buttons (, , , ) to move the cursor to illuminate the desired selection. Press the confirmation button (ENTER) to confirm the menu selection.

▶|| (CONFIRM)



In stop mode, press the play/pause button () to start playing the disc.  
When playing disc, press the play/pause button () to temporarily stop the playing, press the button again, it will continue to play.  
(You can also operate the key "" on the panel of unit.)



Press the stop/return button (■) to stop playing, the unit will store the last playing time in the memory automatically, then press the play/pause button (▶||), the unit will resume to last memory time and continue playback automatically.

If you press the stop/return button (■) twice to stop the disc playing.  
(You can also operate the key "■" on the panel of unit.)

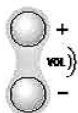

Press the volume up button to increase the volume. Press the volume down button to decrease the volume.

(You can also operate the volume knob "- VOLUME +" on the front panel of unit.)



Press the mute button in play mode, all sound will be muted, press the button again to resume sound. *(Note: The mute function applies to amplifier unit only, it is not available for optical fiber output.)*



Rotate the bass control (**BASS**) on the unit clockwise or anticlockwise to increase/decrease the bass.



Rotate the treble control (**TREBLE**) on the unit clockwise or anticlockwise to increase/decrease the treble.



- This unit has a loudness function, it can automatically increase the bass sound at low volume (the higher the volume, the smaller bass increase), which improves the output sound. You only need to press the loudness button (**LOUD**) to obtain the loudness function when it is playing.
- This unit has three brightness levels for adjusting the display brightness.  
**In standby mode**, press the clock dimmer button (**CLK DIM**), for the desired brightness level.



You can adjust the sound reproduced simply by choosing from different preset equalizations. Each press of the preset equalizer button (**P-EQ**) will select one of the following different preset equalizations:

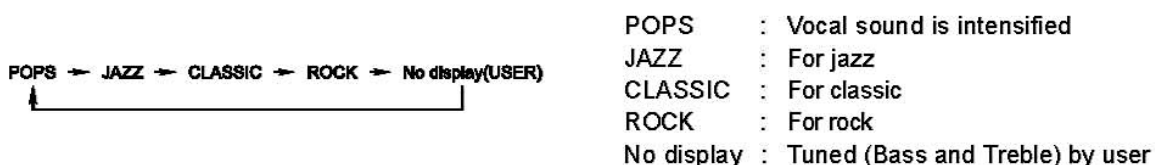

Press the OSD button to display the playing information of the disc on the TV screen.



- If the Video CD has a menu, you can set the playback control function to "PBC ON" mode by pressing the menu button (**MENU**). The unit reads the disc and the menu will display on the TV screen, then use the number buttons to select the desired track.
- When playing DVD disc, press the root button (**MENU**) to return to the root menu for previous layer.



Load a Video CD, disc in PBC OFF mode (the MENU button turns the PBC function ON/OFF). You can select tracks or chapters with the number buttons (0/10, 1-9, 10+).

- \* If the track or chapter number is less than 10, press the number buttons 0/10, 1-9.
- \* If the track or chapter number is over 10, press 10+ button and press the one of the number buttons 0/10, 1-9. (**Note:** If the track or chapter number over 20, press 10+ button twice and press the one of the number buttons 0/10, 1-9.)



- If your DVD disc has one or more music chapters or titles, you can setup playing order for the disc using this button. Press the program button, TV display will be as follows:

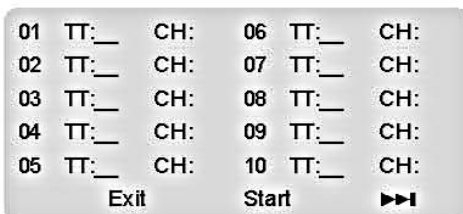

Note: TT: Title  
CH: Chapter

- \* Use the 0/10, 1-9, 10+ buttons to input the sequence number which you want to program playing (the first selection is title and the second selection is chapter of the programs menu.). After finishing program, Press the ▲, ▼, ◀, ▶ buttons to select "Start" then press the **ENTER** button to start programmed play. (If you setup disc playing order over 10, press the "▶▶▶" to setup.)
- If you are playing the general disc, the TV display is as follows:

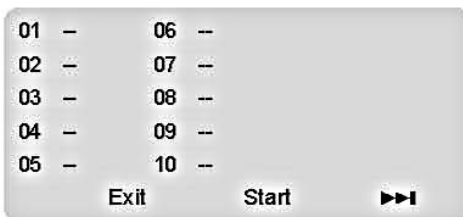

- \* Use the 0/10, 1-9, 10+ buttons to input the sequence number you want to program playing. After the program has been entered, Press the ▲, ▼, ◀, ▶ buttons to select "Start" then press the **ENTER** button to start programmed play. (If you setup a disc playing order over 10, press the "▶▶▶" to continue to the next program screen.)



Some DVD discs may contain scenes which have been shot simultaneously from a number of different angles. For these discs, the same scenes can be viewed from each of these different angles by using the angle button (**ANGLE**).

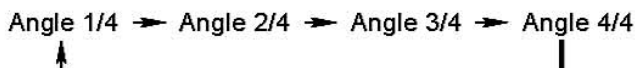

When you are playing the DVD disc, you can repeatedly press the subtitle button (**SUBTITLE**) to select the subtitle language to display on the TV screen if available.

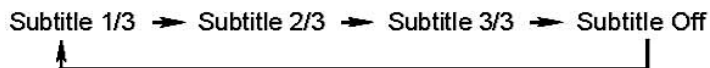

(You can also operate the key "SUBTITLE" on the panel of unit.)



In play mode, press the title button (**TITLE**), to go back to the title menu.



- When playing a the Video CD, you can choose MONO (Mono Left, Mono Right), "STEREO" or "Mix-Mono" audio output by pressing vocal mode select button (**AUDIO**).
- When playing DVD disc recorded with several languages, you can repeatedly press the language select button (**AUDIO**) to select one of language to play.

Audio 1/4 → Audio 2/4 → Audio 3/4 → Audio 4/4

(You can also operate the key "AUDIO" on the panel of unit.)



- When playing a DVD disc, this function can be used to play a title, chapter or disc repeatedly. Repeatedly press the repeat button (**REP**), the screen shows :

CHAPTER → TITLE → ALL → Cancel Repeat

- When playing MP3 disc, this function can be used to play a track or folder repeatedly. Repeatedly press the repeat button (**REP**), the screen shows :

Single → Repeat One → Repeat Folder → Folder

- You may repeat a track or disc according to the following steps. Repeatedly press the repeat button (**REP**), the screen shows :

Track → ALL → Cancel Repeat

(You can also operate the key "REPEAT" on the panel of unit.)



You may directly enter a time, title or chapter number to go to a particular point on the disc. The unit will play from this point.

**Note:** If the search time exceeds the total time on the disc or the item set falls short of the disc recorded, the "⏸" will display on TV screen, indicating the operation is invalid or incorrect.



Press the fast forward button (▶▶) repeatedly to select one of the variety of different speeds to fast forward play or select normal speed to play. Each time you press the button, the screen shows.

2X → 4X → 8X → 16X → 32X → PLAY

**Note:** Press the ▶|| button to resume normal playback.



Press the fast reverse button (◀◀) once by once to select one of the variety of different speeds to fast backward play or select normal speed to play. Each time you press the button, the screen shows.

2X → 4X → 8X → 16X → 32X → PLAY

**Note:** Press the ▶|| button to resume normal playback.



To play the disc in a random order.

Random play begins from the current selection by pressing the random button (**RANDOM**) on the remote control.

INTRO



- When playing CD disc, press the intro button (**INTRO**) to play the beginning of each track consecutively. The playing time of each track is 10 seconds.
- When playing a Video CD disc (except for CD disc), press the intro button (**INTRO**) to enter the thumbnail function, the menu will displayed on the TV screen. Use the **▲,▼** buttons to select digest type (track digest, disc interval or track interval), then press the **ENTER** button to confirm your choice (the TV screen will display the many picture).
  - Turn the **◀▶/▶▶** buttons to select the previous/next 6 tracks picture.
  - Press the **0/10,1-9,10+** buttons to select the desired picture number on the thumbnail function, then press the **ENTER** button to play.
  - Press the **▲,▼,◀,▶** buttons to move the cursor to highlight "Exit" (exit the thumbnail function) or "Menu" (return to "select digest type" menu list), then press the **ENTER** button to confirm your choice.

▶▶(SCAN)



- When playing a DVD disc, press the next button (**▶▶**) to skip to the next chapter or title.
- When playing a Video CD disc, press the next button (**▶▶**) to skip to the next track. (You can also operate the key "▶▶" on the panel of unit.)

◀◀(INFO.)



- When playing DVD disc, press the previous button (**◀◀**) to skip to the previous chapter or title.
- When playing Video CD disc, press the previous button (**◀◀**) to skip to the previous track. (You can also operate the key "◀◀" on the panel of unit.)

ZOOM



This function can be used while playing a film or a still picture.  
Press the zoom button (**ZOOM**) repeatedly when playing, the screen shows :

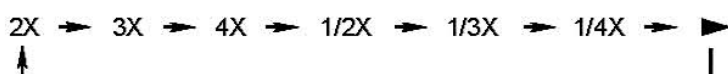

- \* Use the **▲,▼,◀,▶** buttons to move around the enlarged picture.
- Note:** This function is not available for CD or MP3 playback.

## DVD Menu Options

**Caution:** The content of this chart is for reference only. If something has changed, please take the actual display for standard.

For connection details, please refer to Quick Start Guide.

### Menu function setup

SETUP



- \* If you want to setup the function of this unit, please press the function setting button (**SETUP**) to display the DVD setup menu, then use the **▲,▼,◀,▶** buttons and **ENTER** button. Press the function setting button (**SETUP**) again to exit the function setting main menu. (**Note:** If the item displays in gray, that means that it can't be setup and there isn't this function in the disc.)

## General Setup Page

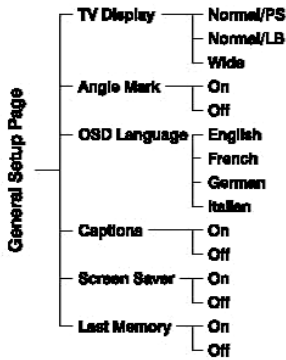

### TV Display

This menu allows the user to select the aspect ratio of the TV to be connected.

### Angle Mark

Available only when the disc is recorded with angle marks, you can set the angle mark to show on the TV screen or not.

### OSD Language

This menu allows the user to select the language for the on-screen display.

### Captions

Set the captions to on/off (if the disc being played has this feature).

### Screen Saver

Set the screen saver to on/off.

### Last Memory

Set the last memory state to on or off.

## Audio Setup Page

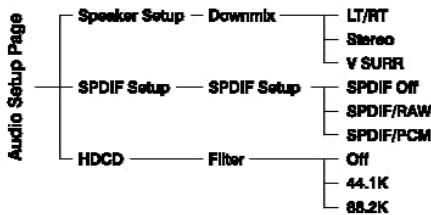

### Speaker Setup

When the disc has Dolby Pro Logic stereo, you can choose LT/RT (Left/Right audio) or Stereo or V SURR (Virtual Surround Sound) mode to play this disc.

### SPDIF Setup

For optical and coaxial output of digital audio signals to your surround sound system.

### HDCD

When playing a HDCD disc, the audio output width degree can be set here.

## Video Setup Page

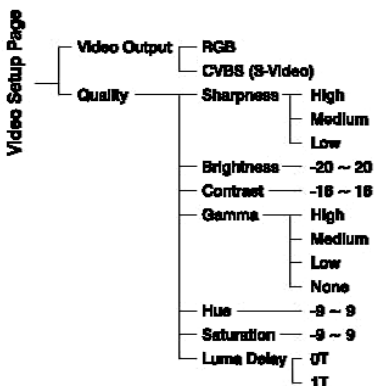

### Component

You can setup this according to TV video output type.

### Quality

You can adjust the picture to your personal preference.



## Preference Page

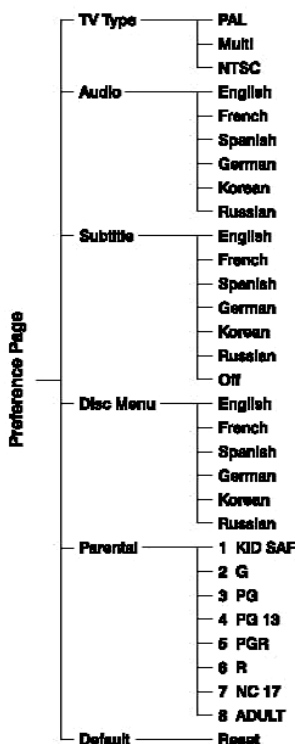

### Audio, Subtitle, Disc Menu

You can select subtitles, different audio tracks and languages in this menu, if available.

### Parental

Setup this system when playing a disc which has age control.

### Default

Restore to factory setting.

## Password Setup Page

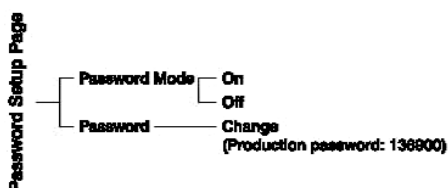

### Password Mode

Select this item to set new password for this unit, follow the screen's indication and enter a password.

### Password

The original password is 136900.

## Picture CD's

### Play picture CD disc

- Place the picture CD on the disc tray correctly, the unit will read the disc and play it automatically.
- When the picture is displayed on the TV screen, you can press the **0/10,1-9** buttons on the remote control to select the desired picture on the disc to start playing.

**Note:** Play will continue until the final picture or when the selected pictures have been played.

- When playing, press program button (**PRG**) to select one of the transition effects to play the picture.
- When playing, use the **MENU** button or **■** button to select different play mode. These play modes list as the following:

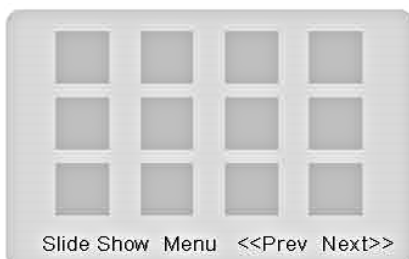

### Note:

- Slide Show : Selections played in a random order
- Menu : Display "Remote Key Function" list
- Prev : Display previous 12 pictures of disc
- Next : Display next 12 pictures of disc

**Note:** When playing a picture CD, press the ■ button to enter the “Thumbnail Mode”, use the ▲,▼,◀,▶ buttons to move the cursor to illuminate the “MENU” then press the ENTER button to enter the “Remote Key Function” list.

PROGRAM	:	Transition Effect	◀	:	Contrarotate
STOP	:	Thumbnail Mode	▶	:	Rotate Clockwise
▶▶	:	Next Picture	ZOOM	:	Switch Zoom Mode
◀◀	:	Previous Picture	▶▶	:	Zoom In
PLAY	:	Picture Mode	◀◀	:	Zoom Out
▲	:	Invert	▲,▼,◀,▶	:	PAN IN Zoom Mode
▼	:	Mirror			

- You may need use the ▲ button on the unit to stop playing and open the disc tray.

## DAB/FM Radio

---

### Listening to Radio Broadcasts

#### DAB/FM

The DAB/FM button is used to select between the DAB and FM Tuners.

When in DAB mode the following message is displayed until the new code has been loaded.

Switching to DAB

When in FM mode the following message is displayed.

Switching to FM

#### DAB Radio

##### ◆ *System Reset*

To reset switch off, then back on at mains supply. Press and hold “CONFIRM” knob/button and press “STANDBY”. Continue to hold “CONFIRM” until the unit displays “System Reset”. The DAB Radio will go into scan mode. (See “Quick Scan” and “Full Scan” for retuning details).

**Warning:** System Reset will clear all DAB and FM Radio Stations.

System Reset

##### ◆ *‘Auto’ Tune (SCAN on the remote)*

This button on the remote activates the ‘Auto’ Tune function which searches for available DAB ensembles and when it locates a valid ensemble it enters the details into the database.

If the button is held down for over 2 seconds then a Full scan is initiated, instead of the usual Quick scan.

##### ◆ *Up/Down Buttons (or SEL-/SEL+ on remote)*

These buttons are used to select new stations/services.

##### ◆ *CONFIRM Button (DAB Mode)*

This button (on the unit and remote) is used to confirm new station/service selection. If the button is held down for more than 2 seconds then manual tuning is activated.

- ◆ **Scrolling Text**

The bottom line displays transmitted text giving information regarding the tuned station transmission.

- ◆ **Storing Stations on Preset Buttons 0-9**

If a preset button is pressed and held for at least 2 seconds, then that assigns the current station to the selected preset.

After 3 seconds the display reverts to the current display mode.

Planet Rock DAB Preset 04 Stored
-------------------------------------

- ◆ **Recalling Station**

If a preset button is pressed and released, then that initiates tuning to the station previously stored under that preset.

Classic DAB Tuning...
--------------------------

If tuning is successful then the display reverts to the tuned state

Classic DAB Air on a G String by
-------------------------------------

If tuning is not successful, then the 'not available' message is displayed.

If no preset has previously been stored then the following message is displayed for 3 seconds...

Planet Rock DAB Preset 01 Empty
------------------------------------

Then reverts to the current station display.

Planet Rock DAB
-----------------

- ◆ **Quick Scan**

If the user presses the SCAN (**Auto Tune**) button briefly, then only a (**Quick**) scan of channels 11A – 12D is undertaken (unless a previous full scan has detected an ensemble outside this range, in which case a persistent flag has been set and a **Full** scan is undertaken instead.

Auto Tune Quick Scan
-------------------------

The above message is displayed on the screen for at least 2 seconds.

- ◆ **Full Scan**

If the user holds the SCAN (**Auto Tune**) button down for at least 2 seconds, then a (**Full**) scan of all channels in Band III is undertaken. The following message is displayed on the screen for at least 2 seconds. If any ensembles are found during the full scan that lie outside the normal UK Band III range, then a persistent flag is set to indicate the fact, to ensure that even a short press of the SCAN (**Auto Tune**) button will initiate a full scan next time.

Auto Tune Full Scan
------------------------

- ◆ **INFO Button (Unit and Remote)**

If the **INFO** button is held down for more than 2 seconds, then this causes the advanced information display to be shown. When the info button is clicked or held subsequently, then the info display returns to the start of the cycle.

Pressing INFO once will give you the following option:

- ◆ **Program Type**

The bottom line displays the static PTY information centred (in the long name format, max. 16 characters).



Pressing INFO twice will give you the following option:

- ◆ **Multiplex Name**

The bottom line displays the Ensemble/Multiplex name centred (in the long name format, max. 16 characters).



Pressing INFO three times will give you the following option:

- ◆ **Signal Quality**

The bottom line displays a graphical representation of the signal quality of the ensemble currently being decoded and shows an indication of the minimum signal quality necessary for successful decoding.

Poor signal quality...



Good signal quality...



The solid block is used to denote the point at which signal quality (hence audio quality) becomes acceptable. Below this point audio may still decode, but audio artifacts (first burbling, then muting) will be heard.

This display will be continuously updated so that the user can use it to position the radio to obtain the best reception.

Pressing INFO four times will give you the following option:

- ◆ **Time and Date**

The bottom line displays the time and the date in the following format.

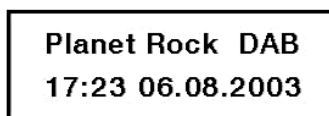

**FM Radio**

◆ **System Reset**

To reset switch off, then back on at mains supply. Press and hold "CONFIRM" knob/button and press "STANDBY". Continue to hold "CONFIRM" until the unit displays "System Reset". FM Radio will go into scan mode.

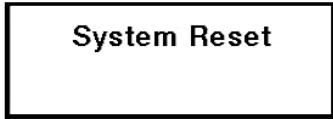

◆ **State Display (Tuned)**

When a user has tuned to a station, the station details are recorded in persistent storage so that if the radio is turned off and then on again, or an invalid preset or offair station is chosen, then the radio can revert to the last station.

The standard tuned display is as follows...



The 'FM in the top left corner, indicates that the radio is in FM mode.

◆ **AutoTune Button (SCAN on the remote)**

This button activates the 'Auto Tune' function which searches for the next available FM station.

◆ **CONFIRM Button**

This button is used to enter the receiver configuration mode, AUTO or MONO. (AUTO will select STEREO if available).

◆ **Select Up/Down Buttons (SEL-/SEL+ on the remote)**

These buttons are used to manually select new stations.

◆ **Storing Stations on Preset Buttons 0-9**

If a preset button is pressed and held for at least 2 seconds, then that assigns the current station to the selected preset (in this example preset 4 is selected).

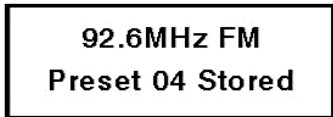

After 3 seconds the display reverts to the current display mode.

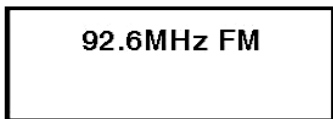

The bottom line of the display will show transmitted text if the station chosen transmits RDS.

◆ **Recalling Station**

If a preset button is pressed and released, then that initiates tuning to the station previously stored under that preset.

If no preset has previously been stored then the following message is displayed for 3 seconds...

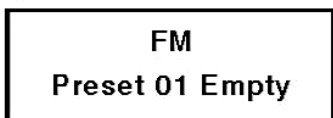

Then reverts to the current station display

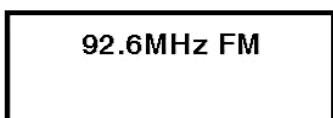

◆ **Signal Quality**

The bottom line displays a graphical representation of the signal quality of the station currently being demodulated.

Poor signal quality...



Good signal quality...



This display will be continuously updated so that the user can use it to position the radio to obtain the best reception.

◆ **Time and Date**

The bottom line displays the time and the date in the following format (requires RDS transmission). If the hours field can be represented by a single digit, then there is a leading zero thus...



## MP3 Functions

---

### Listening to MP3 Player



Press the MP3 function button (**MP3**) to select MP3 function.

If no USB external device is connected, the unit will display total no of files. from the built-in hard disk.

If the USB device is connected, the unit will display total no of files. from USB device.



- In stop mode, press the ►|| button to start playing.
- During play, press the ►|| button to temporarily stop playback, press the button again, it will continue to play.
- In menu setting mode, press the menu confirm button (**CONFIRM**) to confirm menu setting.

(You can also operate the key "►||(**CONFIRM**)" on the panel of MP3 player.)



- Press the ■ button to stop the disc playing.
  - In menu setting mode, press the menu cancel button (**CANCEL**) to cancel menu setting.
- (You can also operate the key "■(**CANCEL**)" on the panel of MP3 player.)



In menu setting mode, press the menu select down button (**SEL-**) to select menu to setting. (You can also operate the key "**SEL-**" on the panel of MP3 player.)



In menu setting mode, press the menu select up button (**SEL+**) to select menu to setting. (You can also operate the key "**SEL+**" on the panel of MP3 player.)



Press the ◀◀ button once or more to skip previous one or more tracks. (You can also operate the key "◀◀" on the panel of MP3 player.)



Press the **▶▶** button once or more to skip forward one or more tracks.  
(You can also operate the key “▶▶” on the panel of MP3 player.)



- In playing mode, you can have the hard disk or USB device played in a random order by pressing the **RANDOM** button.
- In stop mode, press the menu setting button (**MENU**) to enter the menu setting mode.  
(You can also operate the key “**RANDOM(MENU)**” on the panel of MP3 player.)



Press the **INTRO** button to play the beginning of each track consecutively. The playing time of each track is 10 seconds. Press the button again to exit.  
(You can also operate the key “**INTRO**” on the panel of MP3 player.)



ONE and ALL repeat play can be set by pressing the **REP** button.  
First press : To repeat all tracks on a disc.  
Second press : To repeat the same track.  
Third press : To cancel the repeat playing.  
(You can also operate the key “**REPEAT**” on the panel of MP3 player.)



### File Copy Operation

1. With the hard drive/music bank in “STOP” mode and the USB device inserted, then press the copy button (**COPY**) “USB TO HD COPY” will be displayed on the VFD.
2. Use the **SEL-** or **SEL+** button to select “USB TO HD COPY” (from USB device to hard disk) or “HD TO USB COPY” (from hard disk to USB device) and press **CONFIRM** button to confirm your selection.
3. If you selected “USB TO HD COPY” option, the “**SEL+,-CONFIRM SELECT HD OPERATION: C: or D:.**” will be displayed on the VFD. Use the **SEL-** or **SEL+** button to select “C DISK” or “D DISK” and press **CONFIRM** button to confirm your selection, the “USB TO HD COPY COPY ONE” will be displayed on the VFD.
4. Use the **SEL-** or **SEL+** button to select “COPY ONE” (one file) or “COPY ALL” (all files) and press **CONFIRM** button to confirm your selection, the “Copying...” will be displayed on the VFD.

**Note:** If you selected “COPY ONE” (one file), press the **INTRO** button to enter the subdirectory, then press **CANCEL** button to exit the subdirectory.

## MP3 Recording



### Record Synchronization

This function synchronizes recording with the beginning of the track.

1. Before recording, please firstly confirm whether the menu is setup to the record setting you need.
2. Place the CD in the disc tray correctly and cancel play mode by pressing stop. Press the **CD SYNC** button on the unit to select the record synchronization mode. There are two options to record to, HD or external MP3 device. They are selected by using **SEL-** and **SEL+** buttons, The “CD-SYNC TO HD” will be displayed on the VFD.
3. Press the **CONFIRM** button to enter the record synchronization, the “Select HD Operation C: or D:” will scroll across the VFD.
4. Use the **SEL-** or **SEL+** button to select “Rec To C:” or “Rec To D:” and press **CONFIRM** button to confirm your selection, the “WAITING CD SYNC” will be displayed on the VFD.
5. Press the **CANCEL** button to stop recording anytime, the “Write TO HD” will be displayed on the VFD. When the “MP3 STANDBY” is displayed on the VFD, the unit will exit the record synchronization mode and return to DVD normal playing mode.

REC



## Recording

1. Before recording, please firstly confirm whether the menu is setup to the record setting you need.
2. Place the disc on the disc tray correctly and press play. Press the REC button (**REC**) to select the record mode, the "REC TO HARD DISK" will be displayed on the VFD.
3. Press the **CONFIRM** button to enter record, the "Select HD Operation C: or D:" will scroll across the VFD.
4. Use the **SEL-** or **SEL+** button to select "Rec To C:" or "Rec To D:" and press **CONFIRM** button to confirm your selection, the "WAITING..." will be displayed on the VFD.
5. Press the **CANCEL** button to stop recording anytime, the "Write TO HD" will be displayed on the VFD. When the "MP3 STANDBY" is displayed on the VFD, the unit will exit the record mode and return to normal play mode.

**Warning:** Do not remove the USB device while in use. This could damage the file.



Press the menu setting button (**MENU**) repeatedly until "REC. BIT-RATE" is displayed on the VFD, then you can use **SEL-** or **SEL +** button to select the 5 levels of bitrate (64 kbps to 196 kbps for recording from external equipment and press **CONFIRM** button to confirm your selection. (The higher the bitrate, the better the sound quality.)

Press the menu setting button (**MENU**) repeatedly until "CD-SYNC REC" is displayed on the VFD, then you can use **SEL-** or **SEL +** button to select the OFF, ONCE or ALL mode to record songs from external equipment and press **CONFIRM** button to confirm your selection.



- \* Off : Turns record synchronization off
- \* ALL : Synchronized record all tracks of a disc. Each track will be saved as a separate MP3 file.
- \* Once : Synchronized record one track of a disc. Only the first track played will be recorded.

Press the menu setting button (**MENU**) repeatedly until "DELETE" is displayed on the VFD, then you can use the **SEL-** or **SEL +** button to select hard disk or USB device and press **CONFIRM** button to confirm your selection. Use **SEL-** or **SEL+** button to select the file that you want to delete (press the **INTRO** button to enter the subdirectory.) and press **CONFIRM** button to confirm the delete or press **CANCEL** button to cancel.

Press the menu setting button (**MENU**) repeatedly until "MEM SIZE CHECK" is displayed on the VFD, then you can use the **SEL-** or **SEL +** button to select hard disk or USB device and press **CONFIRM** button to confirm your selection. Use **SEL-** or **SEL +** button to check the hard disk total memory and remaining memory, then the USB device memory if inserted.

Press the menu setting button (**MENU**) repeatedly until "BROWSE DIR" is displayed on the VFD, then you can use the **SEL-** or **SEL +** button select DIR to play first track.

Press and hold the menu setting button (**MENU**) until "1.FORMAT, 2.FDISK & FORMAT" are displayed on the VFD, use the **SEL-** or **SEL+** button to select the memory to be formatted between hard disk and USB device. Then press **CONFIRM** button "ARE YOU SURE FORMAT?" will be displayed. Press **CONFIRM** button to confirm to format memory or press **CANCEL** button to cancel.

### Note:

DRM-protected files will only play if you copy them to the player through Windows Media Player or through the music management software provided by the online music store where you purchased the files.



WMA files “can” have DRM protection. In this case the file content is encrypted with a key. For playback and decoding it is necessary to have DRM license files on your computer. DRM license can limit your rights for using these functions. For instance, it can allow only playback and prohibit conversion into other formats. When you download music from the internet sites that require you to pay per song, these licenses may be included with the download.

In order to play these encrypted WMA files in your MP3 player, you will need to use the Windows Media player to copy them to your MP3 player. The traditional “Drag & Drop” method will not work. Here is what you have to do:

- Open your WMA file using your Windows Media Player.
- Click “Copy to CD or Device”
- Select the MP3 player as your device.

*If you don't have a windows media player or if your version of windows media player is outdated, you can download the latest Version for free from microsoft's website:*

*<http://www.microsoft.com/windows/windowsmedia/download/>*

**Please note:**

1. The capacity of the hard disk is 40GB and divided into two 20GB disk partitions C:\ & D:\.
2. If the capacity of your file is over 20GB, you have to respectively copy your file to C:\ & D:\.
3. In order to protect the hard disk and prolong its life, please take care to stop play before changing function, and do not turn off the unit when hard disk is playing.
4. Avoid sharp impacts to the unit.

## Clock/Timer Functions

---

### Setting the Clock

CLOCK



The built-in clock shows the correct time in the display.

- Press the clock button (**CLOCK**) twice (press once in standby mode), hour indicator will blink.
- Set the hour with the ►► button or ◀◀ button.
- Press the clock button (**CLOCK**), minute indicator will blink.
- Set the minute with the ►► button or ◀◀ button.
- Press the clock button (**CLOCK**), the built-in clock starts operating and the seconds start counting from 0.

**Note:**

- \* The operating time of every step shouldn't be longer than 3 seconds or it will return to the original display.
- \* If there is a power failure or the power system is turned off, the clock will lose its setting.

**To confirm the clock time**

When you press the clock button (**CLOCK**), the clock time is displayed. Wait for a few seconds until the display returns to the original display.

## Setting the Daily Timer

SLEEP/TIMER



- In standby mode, you can use the daily timer setting to turn the unit on automatically at a certain time everyday under standby mode. When the setting timer is on, the timer indicator “**⓪**” will display on the VFD, however the clock must be set correctly for the timer function to work.
- In standby mode, press the timer button (**SLEEP**) twice, hour indicator will blink.
- Set the hour with the **▶▶** button or **◀◀** button.
- Press the timer button (**SLEEP**), minute indicator will blink.
- Set the minute with the **▶▶** button or **◀◀** button.
- Press the timer button (**SLEEP**), the selected time is set. Then set the daily timer to “ON” (daily timer set is in effect) or “OFF” (daily timer set is to cancel) by pressing the **▶▶** button or **◀◀** button.

### Note:

- \* You can only set the daily timer only in standby mode.
- \* The operating time of every step shouldn't be longer than 3 seconds or it will return to time display.
- \* The sound source of the “timer on” mode is the same as the sound source when the unit was turned off by the standby switch.

### To confirm the daily time

Press the timer button (**SLEEP**) in standby mode, the daily time is displayed. Wait for a second until the display returns to the time display.

### To cancel the daily timer setting

In standby mode, repeatedly press the timer button (**SLEEP**) until the “ON” will display on the VFD, then you can set the daily timer to “OFF” by pressing the **▶▶** button or **◀◀** button (the daily timer will be cancelled).

Turning off the system also cancels the daily timer.

## Setting the Sleep Timer

SLEEP/TIMER



- Use the sleep timer to turn the system off after a some time when playing. By setting the sleep timer, you can fall asleep and know that your system will turn off by itself rather than playing all night.
- Play a disc or tune in to the desired station.
- If you set the sleep timer first, each time you press the sleep button (**SLEEP**), it changes the number of minutes shown on the VFD in this sequence:

-- → 10 → 20 → ... → 80 → 90 → 00

If you change the sleep timer, each time you press the sleep button (**SLEEP**), it changes the number of minutes shown on the VFD in this sequence:

-- → 5 → 10 → 20 → ... → 80 → 90 → 00

After setting the number of minutes for the sleep timer, the display will return to the display as before setting the sleep timer.

The system is now set to turn off after the number of minutes you set.

### To confirm the sleep time

When pressing the sleep button (**SLEEP**), the remaining sleep time is displayed. After a few seconds the display returns to the original display.

### To cancel the sleep timer setting

Repeatedly press the sleep button (**SLEEP**) until the “00” displays on the VFD.

It can also cancel the sleep timer by restart set the clock or turning off the system.

# Protect the Disc

---

1. To keep the disc clean, please don't touch the disc's surface when you are holding it. You should hold the edge.
2. If the disc is dirty, it will affect the sound quality. Please use the clean and soft cloth to wipe the disc from inside to outside. Don't wipe the disc in circular motion.



3. Don't stick paper on the disc.
4. Don't place discs in direct sunlight or near or on heat sources.
5. After you have finished with the disc, please place it back in its original case. To avoid warping or damage, do not stack discs.
6. Don't play the disc which has flaw or deformation, in case of damaging this player.
7. Clean your discs using only a soft dry cloth. Do not use any chemicals such as benzene, thinner, antistatic or record sprays as these can damage the disc surface.

# Troubleshooting

---

If you are having a problem with your system, check this list for a possible solution before calling for service.

If you can not solve the problem from the hints give here, or the system has been physically damaged, call a qualified person, such as your dealer, for service.

Symptom	Possible Cause	Action
No sound is heard	Connections are incorrect, or loose TV or power amplifier operates wrong The amplifier's receiving signal position is wrong Volume setting to minimum	Check all connections and make corrections Check whether the operation is right Check the position of receive signal  Adjust volume
No picture	Connect wrong or loose TV Operation and setting is wrong	Check all connection and correct it Check whether operation and setting is right
Bad sound quality	Audio connect wrong Audio output mode setting wrong	Check whether audio connection is right Check whether audio output setting is right
The disc does not play	No disc in the tray The disc is upside down The disc is dirty or scratched The unit is foggy inside	Place a disc Place the disc in with the printed side up Clean or replace the disc Take out the disc, turn on the unit for about an hour
Poor radio reception	The antenna is disconnected	Reconnect the antenna securely
Unable to operate the remote control	The path between the remote control and the sensor on the unit is blocked The batteries have lost their charge	Remove the obstruction  Replace the batteries
Operations are disabled	The built-in microprocessor has malfunctioned due to external electrical interference	Unplug the system then plug it back in

# Specification

---

## System

Power supply .....	~230V / 50 Hz
Rated working power consumption .....	≤ 130W
Channel .....	≥ 40dB
Distortion .....	≤ 0.7%
Dimensions .....	DAB: 280(W) x 65(H) x 300(D) mm DVD: 280(W) x 65(H) x 280(D) mm MP3: 280(W) x 65(H) x 280(D) mm AMP: 280(W) x 65(H) x 300(D) mm

## DVD

Frequency response .....	20Hz-20kHz (±3dB)
Video output .....	1 V <sub>P-P</sub>
Horizontal definition .....	≥ 500 (TV)

## TUNER

FM Frequency range .....	87.5-108 MHz
FM Noise limit sensitivity .....	≤ 20μV
FM S/N .....	≥ 46dB
DAB Frequency Range (band III) .....	174 - 240 MHz
Usable Sens. ....	- 95 dBm

## MP3

Internal Memory .....	40GB
Data File Type .....	MP3 & WMA

## Amplifier

Output power .....	50W x 2
Frequency response .....	20Hz - 20kHz (+1/-3dB)
S/N Ratio .....	≥ 65dB

## Speaker

Impedance .....	8Ω
Input power .....	50W
Dimensions .....	200(W) x 325(H) x 270(D) mm

## Remote

Distance .....	6m
Angle .....	± 30°

## Accessories

Antenna .....	1
Speaker connect line .....	2
Power control cable .....	1
Spanner .....	1
Remote control .....	1
Instruction manual .....	1

**Note: Design and specifications are subject to change without prior notice.**



This symbol on the product or in the instructions means that your electrical and electronic equipment should be disposed at the end of life separately from your household waste.

There are separate collection systems for recycling in the EU.

For more information, please contact the local authority or your retailer where you purchased the product.



Partmaster Direct can provide accessories, spares, batteries and replacement parts with Next Day Delivery available upon request.

Please call:

**0870 600 1338**

*(UK customers only)*

Calls charged at National Rate

...or visit our website at [www.partmaster.co.uk](http://www.partmaster.co.uk)